

ABS1510

1.5AMP GLASS PASSIVATED BRIDGE RECTIFIERS

FEATURE

- . Glass passivated junction.
- . Ideal for printed circuit board.
- . Reliable low cost construction utilizing molded plastic technique.
- . High surge current capability.
- . High temperature soldering guaranteed: 260°C/10 seconds at terminals.

MECHANICAL DATA

- . Case: Molded plastic
- . Epoxy: UL 94V-0 rate flame retardant
- . Lead: MIL-STD- 202E, Method 208 guaranteed
- . Polarity: As marked

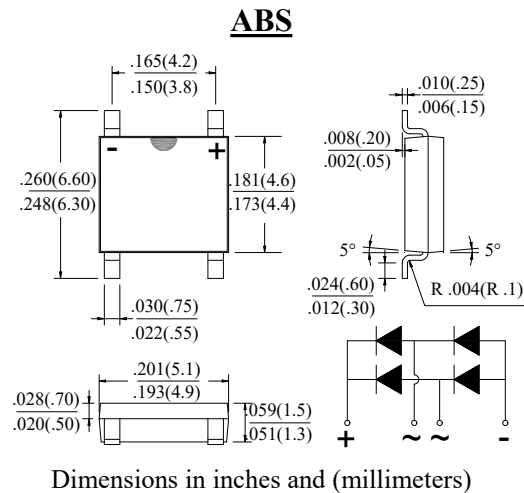

MAXIMUM RATINGS AND ELECTRICAL CHARACTERISTICS

Ratings at 25°C ambient temperature unless otherwise specified.

Single phase, half wave, 60Hz, resistive or inductive load. For capacitive load, derate current by 20%

Type Number	SYM BOL	ABS1510	units
Maximum Recurrent Peak Reverse Voltage	V_{RRM}	1000	V
Maximum RMS Voltage	V_{RMS}	700	V
Maximum DC blocking Voltage	V_{DC}	1000	V
Maximum Average Forward rectified Current	$I_{F(AV)}$	1.5	A
Peak Forward Surge Current 8.3ms single half sine-wave superimposed on rate load (JEDEC method)	I_{FSM}	40	A
Maximum Instantaneous Forward Voltage @ $I_F=1.5A$ DC	V_F	1.1	V
@ $I_F=0.6A$ DC		0.95	
Maximum DC Reverse Current @ $T_J=25^\circ C$	I_R	5.0	μA
at rated DC blocking voltage @ $T_J=125^\circ C$		200.0	
I^2t Rating for Fusing ($t < 8.3ms$)	I^2t	6.64	A ² Sec
Typical Junction Capacitance Per Leg (Note1)	C_J	13	pF
Typical Thermal Resistance (Note2)	R_{JA}	65	$^\circ C / W$
	R_{JC}	22	
Storage Temperature	T_{STG}	-55 to +150	$^\circ C$
Operating Junction Temperature	T_J	-55 to +150	$^\circ C$

Note:

1. Measured at 1.0 MHz and applied reverse voltage of 4.0Vdc
2. Thermal resistance junction to case, lead and ambient in accordance with JESD-51.

Unit mounted on glass-epoxy substrate with 1oz/ft² 15x15 mm copper pad per pin with heatsink

RATING AND CHARACTERISTIC CURVES

FIG.1-TYPICAL FORWARD CURRENT DERATING CURVE

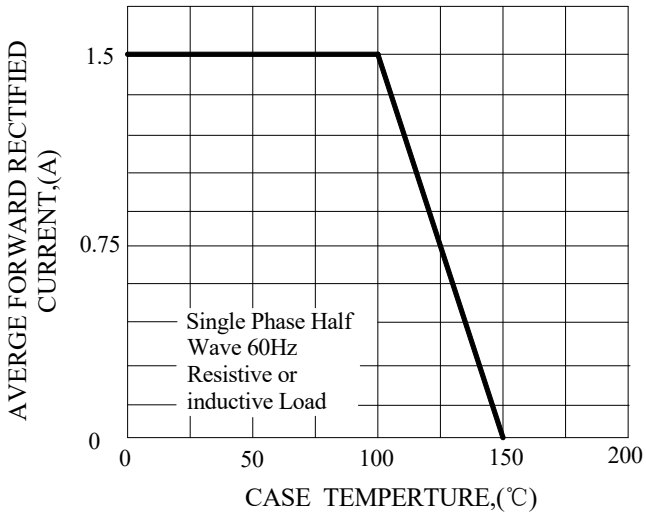

FIG.2-TYPICAL INSTANTANEOUS FORWARD CHARACTERISTICS

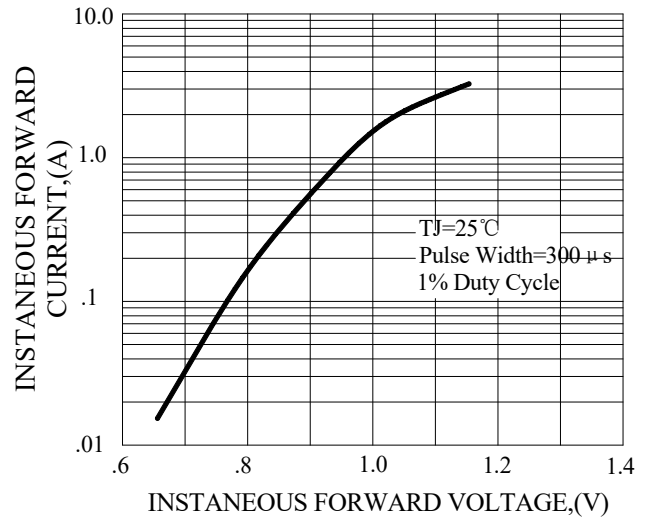

FIG.3-MAXIMUM NON-REPETITIVE FORWARD SURGE CURRENT

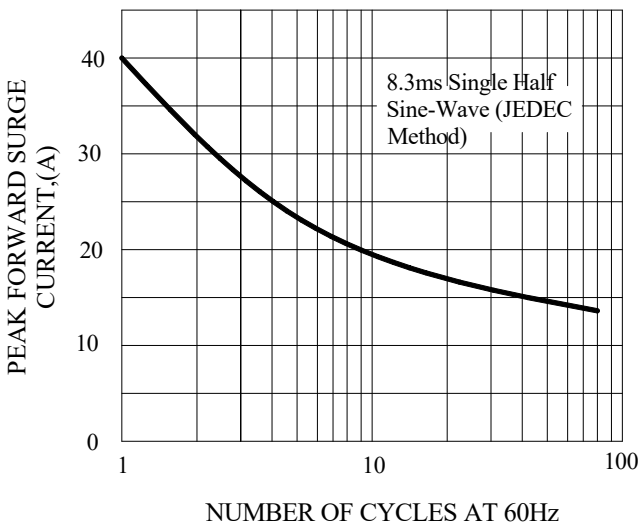
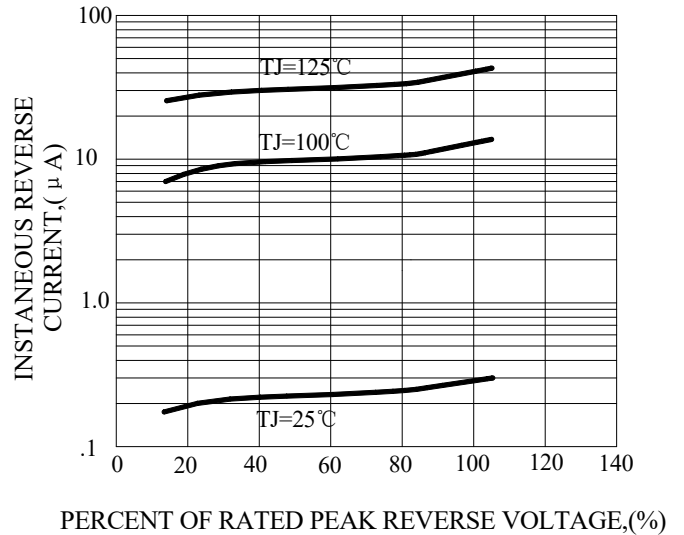
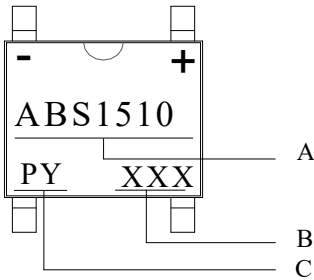

FIG.4-TYPICAL REVERSE CHARACTERISTICS



Marking and packaging illustration

1、Marking



SYMBOL	Explanation
A	Product Name
B	Date Code
C	Trademark

2、Packaging

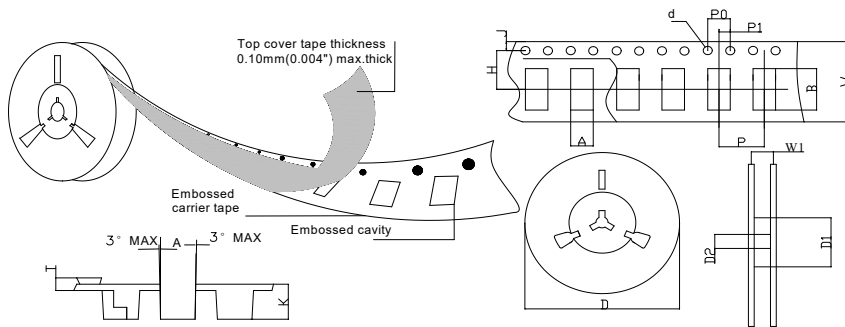

SPECIFICATIONS mm(inch)		PACKAGE	SPECIFICATIONS mm(inch)		PACKAGE
ITEM	SYM BOL	ABS	ITEM	SYM BOL	ABS
Carrier width	A	5.45(0.215)Max	Carrier depth	K	1.60(0.063)Typ
Carrier length	B	7.0(0.276)Max	Punch hole pitch	P	8.00(0.315)Typ
Sprocket hole	d	ø1.55(0.061)Typ	Sprocket hole pitch	P0	4.00(0.157)Typ
Reel outer diameter	D	330.0(13.0)Typ	Embossment center	P1	2.00(0.079)Typ
Reel inner diameter	D1	50.0(2.913)Min	Overall tape thickness	T	0.30(0.012)Typ
Feed hole diameter	D2	13.0(0.512)Typ	Tape width	W	12.0(0.472)Typ
Sprocket hole position	J	1.75(0.069)Typ	Reel width	W1	12.4(0.488)Min
Punch hole position	H	5.50(0.217)Typ			